

DESCRIPTION

The MI402 PIN diode is employing a high reliability glass construction, designed for solid state antenna switches in commercial two-way radios.

FEATURES

- High power handling
- Low insertion loss, High isolation

APPLICATION

High power antenna switch (25W output two-way radio)

OUTLINE DRAWING

Dimension: mm

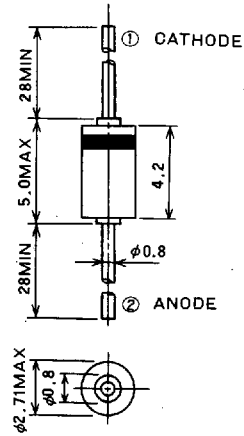

ABSOLUTE MAXIMUM RATINGS (Ta=25°C)

Symbol	Parameter	Rating	Unit
V _{RM}	Repetitive peak reverse voltage	270	V
I _{FSM} *	Forward surge current	2.0	A
P	Power dissipation	1.0	mW
T _j	Junction temperature	175	°C
T _{stg}	Storage temperature	-55 to 175	°C

* : t=5sec

ELECTRICAL CHARACTERISTICS (Ta=25°C)

Symbol	Parameter	Test conditions	Limits			Unit
			Min	Typ	Max	
I _{R1}	Reverse current	V _R =270V			10.0	μA
I _{R2}	Reverse current	V _R =200V			150	nA
I _F	Forward current	V _F =1.0V	500			mA
C _t	Diode capacitance	V _R =12V, f=1MHz			3.0	pF
r _{fs}	Forward series resistance	I _F =50mA, f=470MHz			0.7	Ω
f _c	Cut-off frequency	V _R =12V, f=50MHz	1.0			GHz

TYPICAL PERFORMANCE DATA

FORWARD SERIES RESISTANCE VS. FORWARD CURRENT CHARACTERISTICS

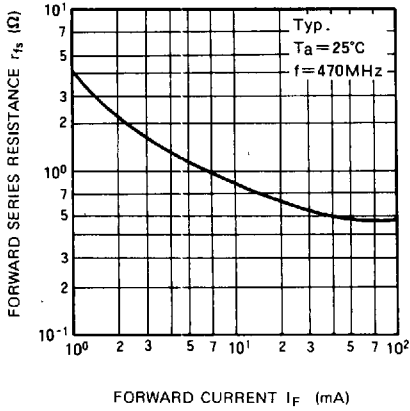

DIODE CAPACITANCE VS. REVERSE VOLTAGE CHARACTERISTICS

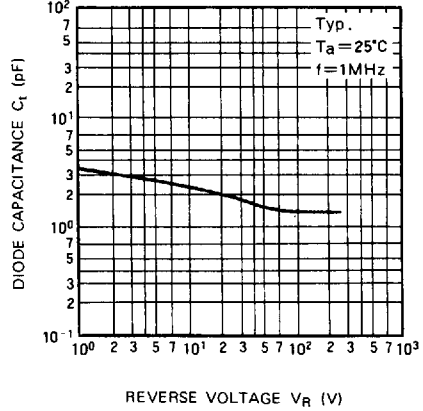

FORWARD CURRENT VS. FORWARD VOLTAGE CHARACTERISTICS

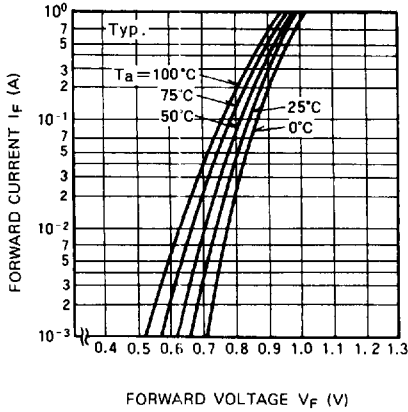

REVERSE CURRENT VS. REVERSE VOLTAGE CHARACTERISTICS

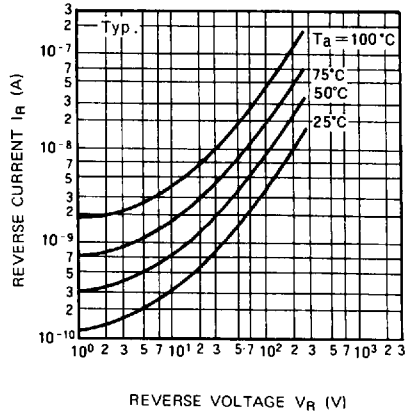

Q VS. REVERSE VOLTAGE CHARACTERISTICS

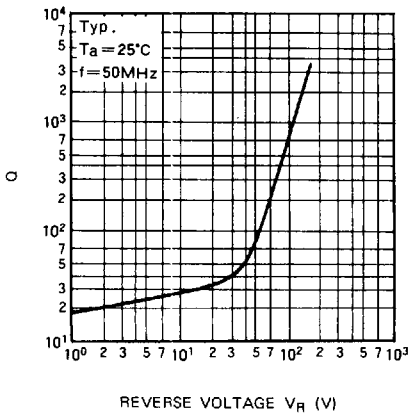

ALLOWABLE POWER DISSIPATION VS. AMBIENT TEMPERATURE CHARACTERISTICS

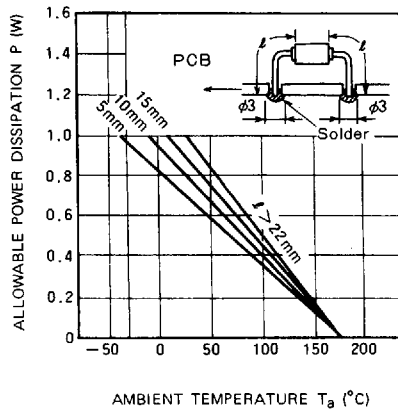

**THERMAL RESISTANCE
(JUNCTION TO AMBIENT) VS. AREA
CHARACTERISTICS**

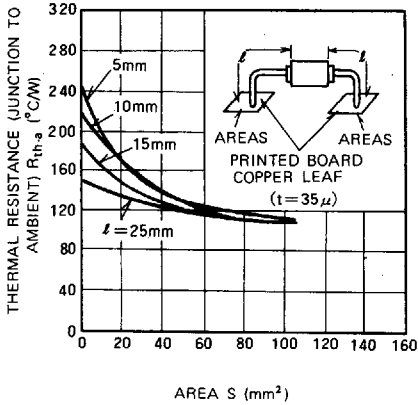

**INDUCTANCE VS. TOTAL
LEAD LENGTH CHARACTERISTICS**

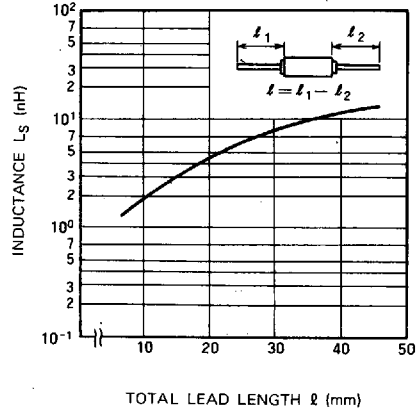

APPLICATION

**SINGLE POLE DOUBLE THROW
SWITCHING CIRCUIT**

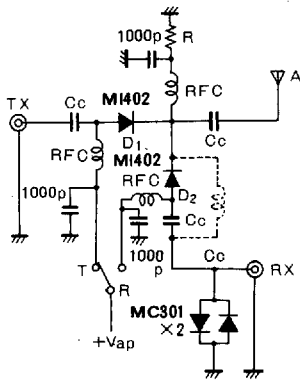

TYPICAL DATA

f	Isolation TX→RX	Insertion Loss TX→A
29MHz	40dB	0.3dB
50MHz	39dB	0.3dB
144MHz	39dB	0.3dB
220MHz	38dB	0.4dB
440MHz	36dB	0.5dB

HANDLING POWER 25W
BIAS CURRENT 50mA DC
SPRIOUS >80dB

**SINGLE POLE DOUBLE THROW
SWITCHING CIRCUIT (λ/4 TYPE)**

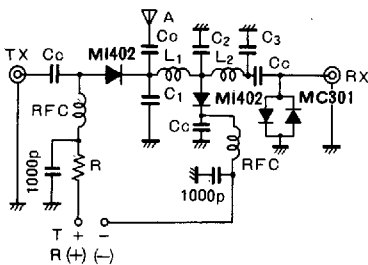

	C1	C2	C3	L1, L2
50MHz	45pF	90pF	35pF	230nH
144MHz	15pF	22pF	4pF	75nH
220MHz	8pF	15pF	3pF	50nH
440MHz	2pF	5pF	2pF	25nH

TYPICAL DATA

f	Isolation TX→RX	Insertion Loss TX→A
50MHz	27dB	0.3dB
144MHz	33dB	0.3dB
220MHz	31dB	0.4dB
440MHz	24dB	0.5dB

HANDLING POWER 25W
BIAS CURRENT 50mA DC
SPRIOUS >80dB